

# POTENCJOMETRY, PRZEKAŹNIKI, PRZEŁĄCZNIKI

## Potencjometry

## LINIOWE

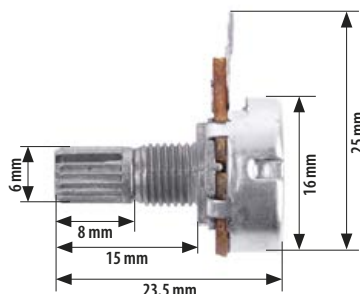

NR KATALOGOWY	OPÓR
PRK0059	0.5 K
PRK0060	1 K
PRK0061	2 K
PRK0051	4.7 K
PRK0062	10 K
PRK0063	50 K
PRK0064	100 K
PRK0065	200 K
PRK0066	500 K

## Przełączniki



PRE0001



### PRZEKAŹNIK 4088-10A/24V

- I max: 10 A (5 A)
- U max: 120 V AC (250 V DC)
- R cewki: 1700 Ω
- In: 15 mA
- Trwałość mechaniczna 10<sup>7</sup> przełączeń
- Wymiary: 16x20x23 mm



PRE0002-10



### PRZEKAŹNIK 4088-10A/12V

- I max: 10 A (5 A)
- U max: 120 V AC (250 V DC)
- R cewki: 680 Ω
- In: 18 mA
- Trwałość mechaniczna 10<sup>7</sup> przełączeń
- Wymiary: 16x20x23 mm



PRE0002B



### PRZEKAŹNIK 4088-10A/12V

- I max: 10 A (5 A)
- U max: 120 V AC (250 V DC)
- R cewki: 680 Ω
- In: 18 mA
- Trwałość mechaniczna 10<sup>7</sup> przełączeń
- Wymiary: 16x20x23 mm



PRE0003



### PRZEKAŹNIK 4098-2A/12V

- I max: 2 A
- U max: 120 V DC
- R cewki: 400 Ω
- In: 30 mA
- Trwałość mechaniczna 10<sup>7</sup> przełączeń
- Wymiary: 15x18x14 mm



PRE0004



### PRZEKAŹNIK 4120-40A/12V

- I max: 40 A
- U max: 50 V DC
- R cewki: 82 Ω
- In: 150 mA
- Trwałość mechaniczna 10<sup>7</sup> przełączeń
- Wymiary: 28.5x28.5x25 mm



PRE0012



### PRZEKAŹNIK 4120-40A/24V

- I max: 40 A
- U max: 50 V DC
- R cewki: 300 Ω
- In: 80 mA
- Trwałość mechaniczna 10<sup>7</sup> przełączeń
- Wymiary: 28.5x28.5x25 mm



PRE0005



**PRZEKAŹNIK LR4141-30A/12V**

- I max: 30 A
- U max: 50 V DC
- R cewki: 82 Ω
- I<sub>n</sub>: 150 mA
- Trwałość mechaniczna 10<sup>7</sup> przełączeń
- Wymiary: 27x27x25 mm



PRE0006



**PRZEKAŹNIK 4123-12A/12V**

- I max: 12 A
- U max: 120 V AC (250 V DC)
- R cewki: 400 Ω
- I<sub>n</sub>: 30 mA
- Trwałość mechaniczna 10<sup>7</sup> przełączeń
- Wymiary: 16x22x16 mm



PRE0007



**PRZEKAŹNIK JQX-15F-30A/12V**

- I max: 30 A
- U max: 120 V DC
- R cewki: 400 Ω
- I<sub>n</sub>: 30 mA
- Trwałość mechaniczna 10<sup>7</sup> przełączeń
- Wymiary: 28x32x20 mm



PRE0011



**PRZEKAŹNIK JQX-105F-1-30A/12V**

- I max: 30 A
- U max: 250 V AC
- R cewki: 150 Ω
- I<sub>n</sub>: 80 mA
- Trwałość mechaniczna 10<sup>7</sup> przełączeń
- Wymiary: 15x19x15 mm



**GNIAZDO PRZEKAŹNIKA SAMOCHODOWEGO Z KABLEM**

- Pasuje do: PRE0004, PRE0005, PRE0012

PRE0008

**Przełączniki**



PRK0001

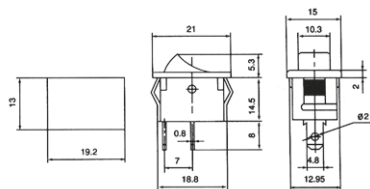

**PRZEŁĄCZNIK MRS-101-2**

- ON-OFF
- Obudowa SPST 2P (2-pinowy)
- 6 A - 125 V AC
- 3 A - 250 V AC



PRK0001A



**PRZEŁĄCZNIK MRS-101**

- ON-OFF
- Obudowa SPST 2P (2-pinowy)
- 6 A - 125 V AC
- 3 A - 250 V AC



PRK0002

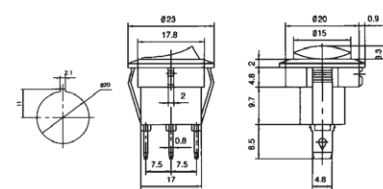

**ZŁĄCZE - PRZEKAŹNIK**

- ON-OFF
- 230 V

NR KATALOGOWY	KOLOR
PRK0002B	CZERWONY
PRK0002C	NIEBIESKI
PRK0002D	ZIELONY
PRK0002E	ŻÓŁTY



PRK0004

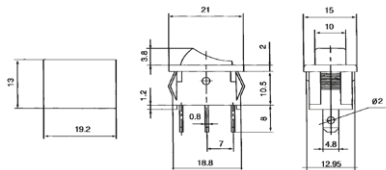

**PRZEŁĄCZNIK MRS103A**

- ON-OFF-ON
- Obudowa SPDT 3P (3-pinowy)
- 10 A - 125 V AC
- 6 A - 250 V AC



PRK0005

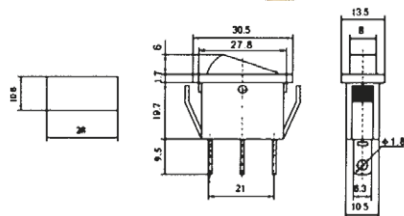

**PRZEŁĄCZNIK IRS-101-1A**

- ON-OFF
- Obudowa SPST 3P (3-pinowy)
- 20 A - 230 V AC



PRK0008B

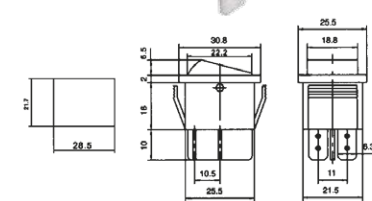

**PRZEŁĄCZNIK IRS-201-1A**

- ON-OFF
- Obudowa SPST 3P (3-pinowy)
- 20 A - 230 V AC



PRK0006

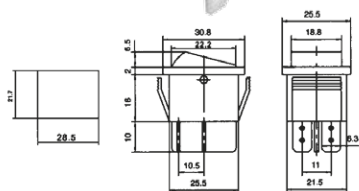

**PRZEŁĄCZNIK IRS-201-1A**

- ON-OFF
- Obudowa DPST 4P (4-pinowy)
- 20 A - 125 V AC; 15 A - 250 V AC
- 25 A - 12 V DC

NR KATALOGOWY	KOLOR
PRK0006B	CZERWONY
PRK0006C	NIEBIESKI
PRK0006D	ZIELONY
PRK0006E	ŻÓŁTY



PRK0007

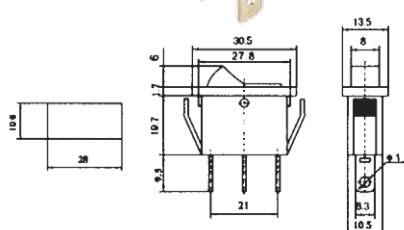

**PRZEŁĄCZNIK IRS-101-1B**

- ON-OFF
- Obudowa SPST 3P (3-pinowy)
- 20 A - 230 V AC

NR KATALOGOWY	KOLOR
PRK0007B	CZERWONY
PRK0007C	NIEBIESKI
PRK0007D	ZIELONY
PRK0007E	ŻÓŁTY



PRK0011

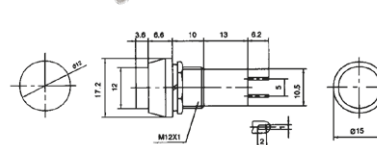

**PRZEŁĄCZNIK PBS 11A**

- ON-OFF
- 1 A - 250 V AC

NR KATALOGOWY	KOLOR
PRK0011A	CZARNY
PRK0011B	CZERWONY
PRK0011C	NIEBIESKI
PRK0011D	ZIELONY
PRK0011E	ŻÓŁTY



PRK0009

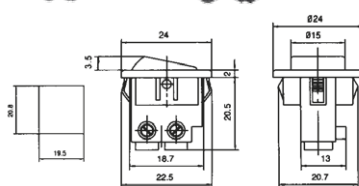

**PRZEŁĄCZNIK RS-101-7C**

- ON-OFF
- Obudowa SPST 2P (2-pinowy)
- 10 A - 125 V AC
- 6 A - 250 V AC

NR KATALOGOWY	KOLOR
PRK0009A	CZARNY
PRK0009C	NIEBIESKI



PRK0013

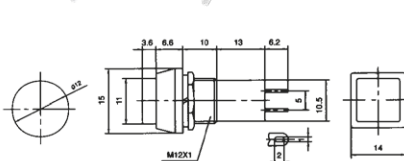

**PRZEŁĄCZNIK PBS-12A**

- ON-OFF
- 1 A - 250 V AC

NR KATALOGOWY	KOLOR
PRK0013B	CZERWONY
PRK0013D	ZIELONY



PRK0019

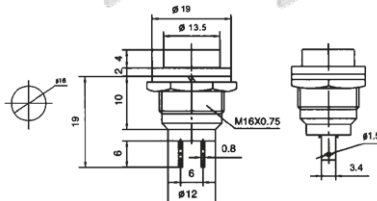

**PRZEŁĄCZNIK PBS26B**

- PUSH ON
- 4 A - 125 V AC
- 2 A - 250 V AC

NR KATALOGOWY	KOLOR
PRK0019A	CZARNY
PRK0019B	CZERWONY

Przełączniki

PRK0012

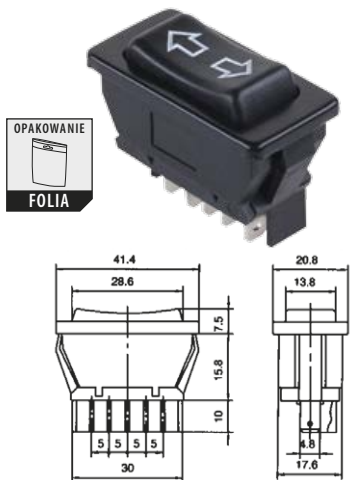

**PRZEŁĄCZNIK ASW-01**

- Obudowa DPDT 5P (5-pinowy)
- 20 A - 12 V DC
- 10 A - 30 V DC

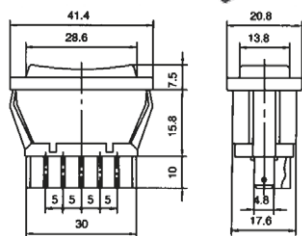

PRK0014

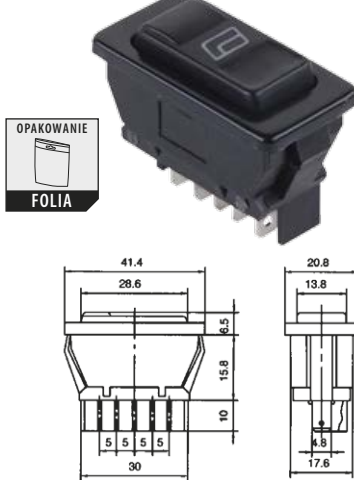

**PRZEŁĄCZNIK ASW-02D**

- Obudowa DPDT 5P (5-pinowy)
- 20 A - 12 V DC
- Podświetlany; do sterowania szybami

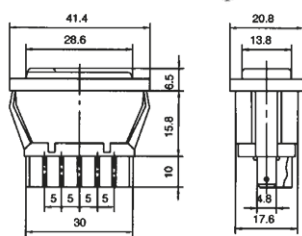

PRK0021

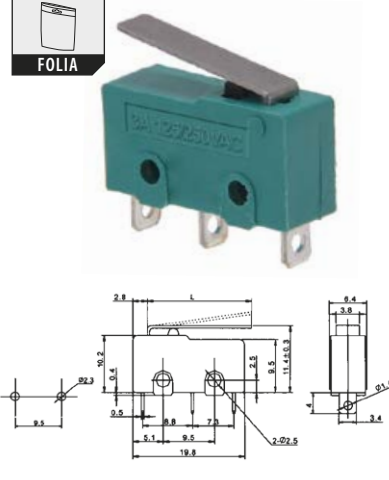

**PRZEŁĄCZNIK MSW-12B**

- ON-ON
- Obudowa SPDT 3P (3-pinowy)
- 3 A - 250 V AC

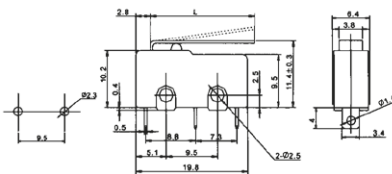

PRK0016

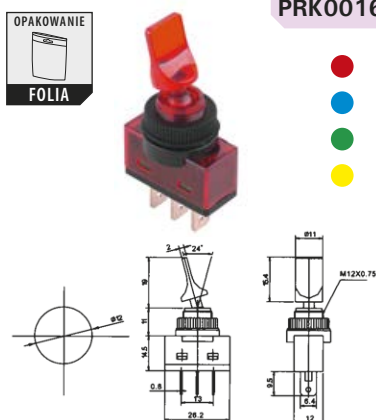

**PRZEŁĄCZNIK ASW-14D**

- ON-OFF
- Obudowa SPST 3P (3-pinowy)
- 20 A - 12 V DC

NR KATALOGOWY	KOLOR
PRK0016B	CZERWONY
PRK0016C	NIEBIESKI
PRK0016D	ZIELONY
PRK0016E	ŻÓŁTY

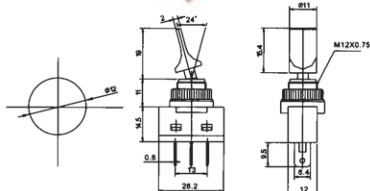

PRK0018

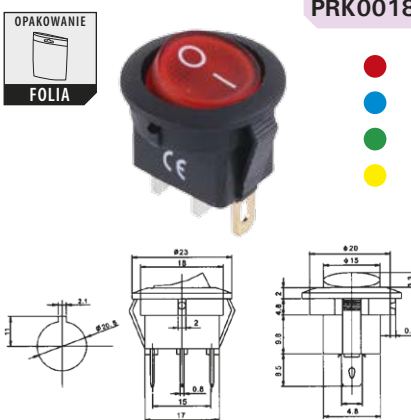

**PRZEŁĄCZNIK IRS-101-8C/D**

- ON-OFF
- Obudowa SPST 3P (3-pinowy)
- 20 A - 12 V DC

NR KATALOGOWY	KOLOR
PRK0018B	CZERWONY
PRK0018C	NIEBIESKI
PRK0018D	ZIELONY
PRK0018E	ŻÓŁTY

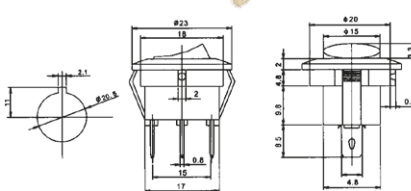

PRK0020

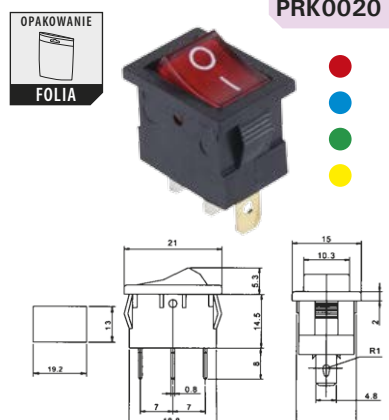

**PRZEŁĄCZNIK MK1011**

- ON-OFF
- Obudowa SPST 3P (3-pinowy)
- 10 A - 12 V DC

NR KATALOGOWY	KOLOR
PRK0020B	CZERWONY
PRK0020C	NIEBIESKI
PRK0020D	ZIELONY
PRK0020E	ŻÓŁTY

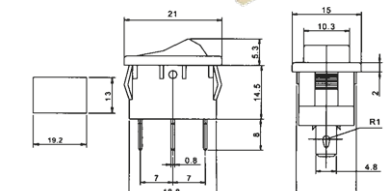

Przełączniki

PRK0022

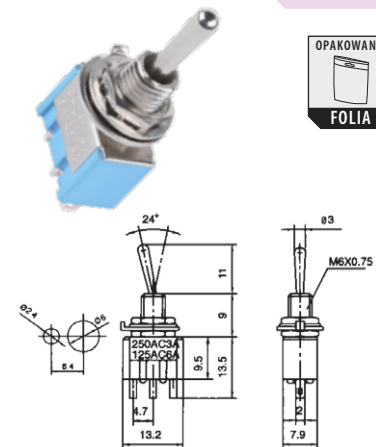

**PRZEŁĄCZNIK MTS 100**

- Obudowa SPDT 3P (3-pinowy)
- 6 A - 125 V AC
- 3 A - 250 V AC

NR KATALOGOWY	TRYB
PRK0022-102	ON-ON
PRK0022-103	ON-OFF-ON

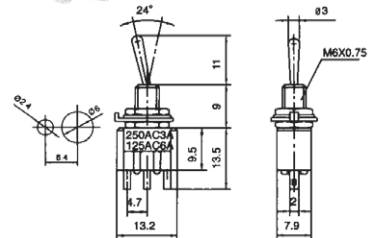

PRK0026

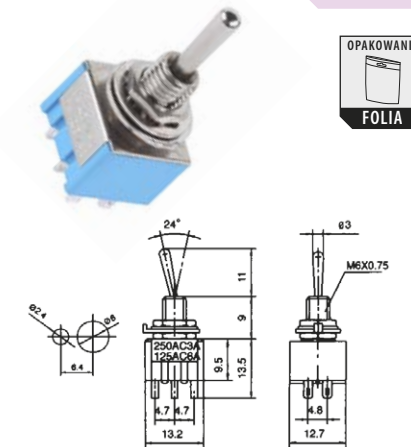

**PRZEŁĄCZNIK MTS 200**

- Obudowa DPDT 6P (6-pinowy)
- 6 A - 125 V AC
- 3 A - 250 V AC

NR KATALOGOWY	TRYB
PRK0026-202	ON-ON
PRK0026-203	ON-OFF-ON

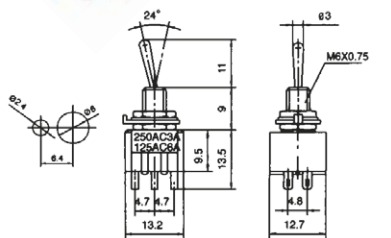

PRK0027

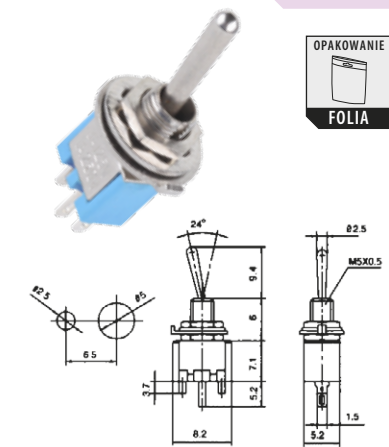

**PRZEŁĄCZNIK SMTS 100**

- Obudowa SPDT 3P (3-pinowy)
- 3 A - 125 V AC
- 1 A - 250 V AC

NR KATALOGOWY	TRYB
PRK0027-102	ON-ON
PRK0027-103	ON-OFF-ON

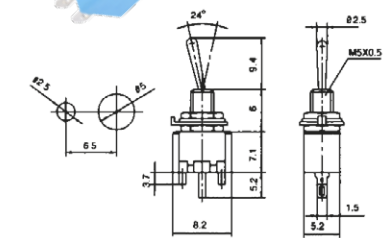

PRK0028

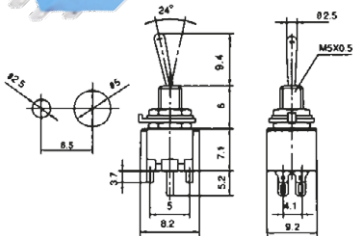

**PRZEŁĄCZNIK SMTS 200**

- Obudowa SPDT 6P (6-pinowy)
- 3 A - 125 V AC
- 1 A - 250 V AC

NR KATALOGOWY	TRYB
PRK0028-202	ON-ON
PRK0028-203	ON-OFF-ON

PRK0030-1

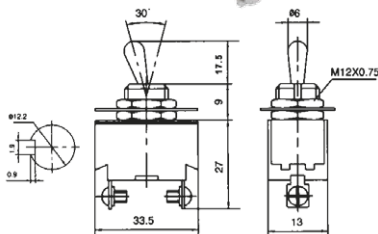

**PRZEŁĄCZNIK KN3(C)-101**

- ON-OFF
- Obudowa SPST 2P (2-pinowy)
- 10 A - 125 V AC
- 6 A - 250 V AC

PRK0030-2

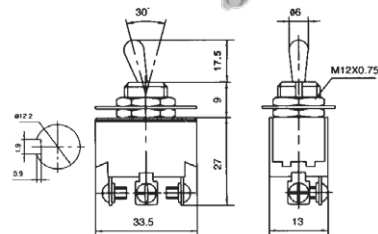

**PRZEŁĄCZNIK KN3(C)-102**

- ON-ON
- Obudowa SPDT 3P (3-pinowy)
- 10 A - 125 V AC
- 6 A - 250 V AC

PRK0030-3

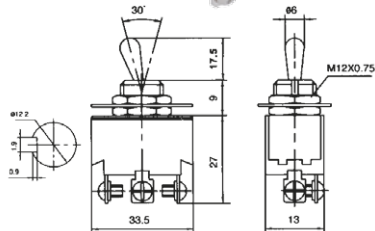

**PRZEŁĄCZNIK KN3(C)-103**

- ON-OFF-ON
- Obudowa SPDT 3P (3-pinowy)
- 10 A - 125 V AC
- 6 A - 250 V AC

PRK0031-1

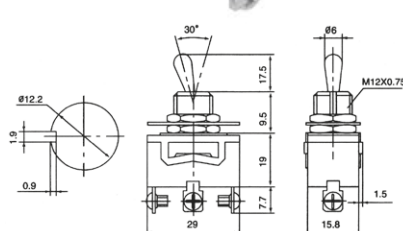

**PRZEŁĄCZNIK KN3(C)-201**

- ON-OFF
- Obudowa DPST 4P (4-pinowy)
- 10 A - 125 V AC
- 6 A - 250 V AC

PRK0031-2

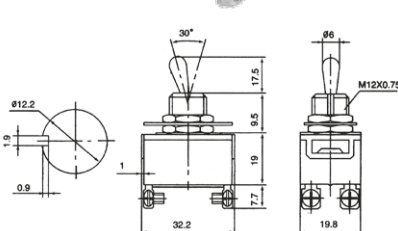

**PRZEŁĄCZNIK KN3(C)-202**

- ON-ON
- Obudowa DPDT 6P (6-pinowy)
- 10 A - 125 V AC
- 6 A - 250 V AC

PRK0031-3

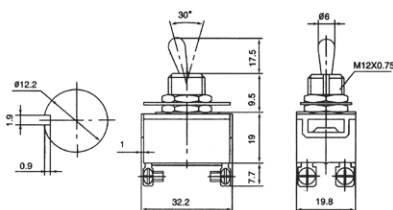

**PRZEŁĄCZNIK KN3(C)-203**

- ON-OFF-ON
- Obudowa DPDT 6P (6-pinowy)
- 10 A - 125 V AC
- 6 A - 250 V AC

PRK0041

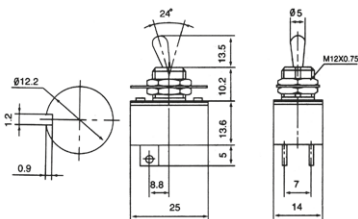

**PRZEŁĄCZNIK KN3-1**

- ON-OFF
- Obudowa SPST 2P (2-pinowy)
- 4 A - 125 V AC
- 2 A - 250 V AC

PRK0042

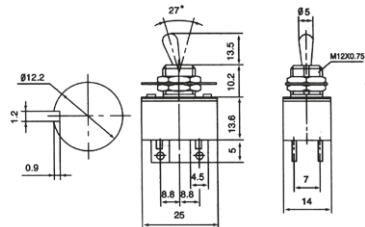

**PRZEŁĄCZNIK KN3-2**

- ON-OFF
- Obudowa STDT 4P (4-pinowy)
- 4 A - 125 V AC
- 2 A - 250 V AC

Przełączniki



PRK0098



**PRZEŁĄCZNIK KN3(B)-123 BISTABILNY**

- ON-OFF-ON
- Obudowa SPDT 3P
- 10 A - 125 V AC
- 6 A - 250 V AC



PRK0099



**PRZEŁĄCZNIK KN3(B)-223 BISTABILNY - CHWIŁOWY**

- ON-OFF-ON
- Obudowa SPDT 6P
- 10 A - 125 V AC
- 6 A - 250 V AC



PRK0100



**PRZEŁĄCZNIK KN3(D)-123 CHWIŁOWY**

- ON-OFF-ON
- Obudowa SPDT 3P
- 25 A - 12 V DC



PRK0044

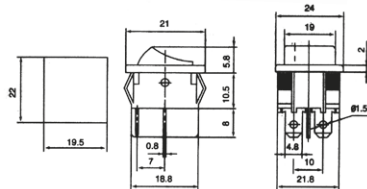

**PRZEŁĄCZNIK MRS-201A**

- ON-OFF
- Obudowa DPST 4P (4-pinowy)
- 10 A - 125 V AC
- 6 A - 250 V AC



PRK0046

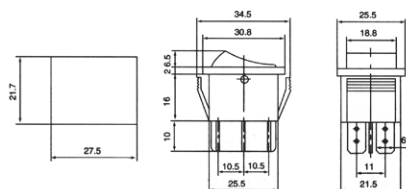

**PRZEŁĄCZNIK IRS-203-1C**

- ON-OFF-ON
- Obudowa DPDT 6P (6-pinowy)
- 20 A - 125 V AC
- 15 A - 250 V AC



PRK0047C

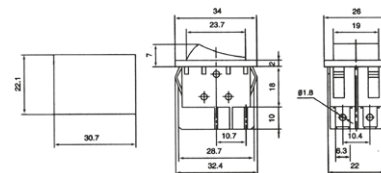

**PRZEŁĄCZNIK IRS-201-3C**

- ON-OFF
- Obudowa DPST 4P (4-pinowy)
- 20 A - 125 V AC
- 15 A - 250 V AC



PRK0048

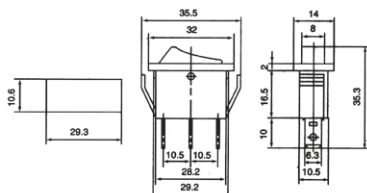

**PRZEŁĄCZNIK IRS-103-3C**

- ON-OFF-ON
- Obudowa SPDT 3P (3-pinowy)
- 20 A - 125 V AC
- 15 A - 250 V AC



PRK0049

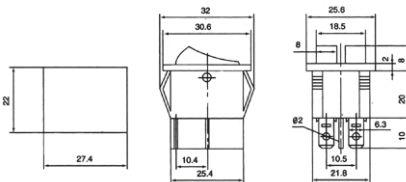

**PRZEŁĄCZNIK IRS-2101-1C**

- 2x ON-OFF
- Obudowa DPDT 6P (6-pinowy)
- 20 A - 125 V AC
- 15 A - 250 V AC



PRK0050

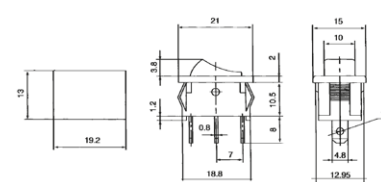

**PRZEŁĄCZNIK MRS-102**

- ON-ON
- Obudowa SPDT 3P (3-pinowy)
- 6 A - 125 V AC
- 3 A - 250 V AC

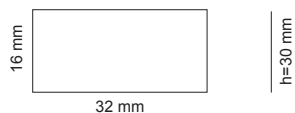
**PRK0035****PRZELĄCZNIK IRS001A**

- ON-OFF
- Obudowa SPST 3P (3-pinowy)
- 10 A - 250 V AC
- 30 A - 3-8 sek

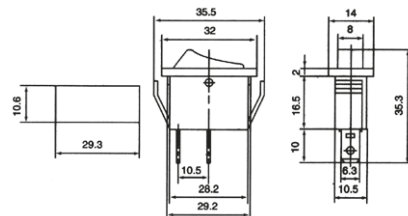
**PRK0036****PRZELĄCZNIK RS-101-3B**

- ON-OFF
- Obudowa SPST 2P (2-pinowy)
- 20 A - 125 V AC
- 15 A - 250 V AC

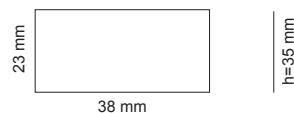
**PRK0040****PRZELĄCZNIK ASW-17D**

- Obudowa DPST 4P (4-pinowy)
- 35 A - 12 V DC
- Podświetlany

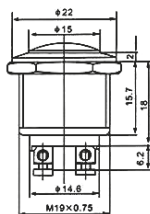
**PRK0052****PRZELĄCZNIK PBS-28B**

- PUSH ON
- 4 A - 125 V AC
- 2 A - 250 V AC

**PRK0083****PRZELĄCZNIK C5N 0-1**

- ON-OFF
- 2P (2-pinowy)
- 16 A - 250 V AC

**PRK0089****PRZELĄCZNIK Z FUNKCJĄ RESET**

- 10 A - 230 V AC

**PRK0101****PRZELĄCZNIKRS-223-4C CHWILOWY**

- 20 A - 125 V AC
- 15 A - 230 V AC

**PRK0054****PRZELĄCZNIK POCIĄGOWY SZNUREK****PRK0089-16****PRZELĄCZNIK Z FUNKCJĄ RESET**

- 16 A - 230 V AC



PRZELOTOWY 2A/250V



**PRK0067**  
BIAŁY



**PRK0068**  
BRĄZOWY



**PRK0069**  
CZARNY



**PRK0070**  
SREBRNY



**PRK0071**  
ZŁOTY



**PRK0108**  
PRZEŹROCZYSTY



PRZELOTOWY 2,5A/250V



**PRK0102**  
BIAŁY



**PRK0104**  
BRĄZOWY



**PRK0103**  
CZARNY



**PRK0105**  
SREBRNY



**PRK0106**  
ZŁOTY



**PRK0107**  
PRZEŹROCZYSTY



PRZELOTOWY-DUŻY 3A/250V



**PRK0072**  
BIAŁY



**PRK0088**  
BRĄZOWY



**PRK0073**  
CZARNY



**PRK0084**  
SREBRNY



**PRK0074**  
ZŁOTY



## PRZELOTOWY-NOŻNY 1A/250V



**PRK0075**  
BIAŁY



**PRK0076**  
BRĄZOWY



**PRK0077**  
CZARNY



**PRK0078**  
SREBRNY



**PRK0079**  
ŻŁOTY

## KOŁYSKOWY-OKRĄGLY R5 10A/250V



- Wysokość 10 mm
- Średnica 18 mm



**PRK0080**  
BIAŁY



**PRK0090**  
BRĄZOWY



**PRK0081**  
CZARNY



**PRK0082**  
SZARY

## ŁAŃCUSZKOWY 3A/250V

**PRK0053**  
SREBRNY



**PRK0055**  
MOSIĄDZ



**PRK0056**  
ŻŁOTY



**PRK0058**  
CZARNY



**PRK0085**  
ANTYCZNY MOSIĄDZ



**PRK0086**  
MIEDZIANY



**PRK0087**  
GRAFITOWY



